

be famous for beauty and comfort

What is your home for you? A place of rest and relaxation after a heavy day at work? A refuge you can share only with your family, with your closest ones? Or perhaps - on the contrary - a space where everyone is welcomed, a space filled with fun and flourishing friendships? No matter how you like to spend your time: Your Home is your kingdom. The centre of this kingdom is usually a living room, with a sofa where most things are going on, aren't they? Talks, meetings, relaxation, fun... this is where you build relationships, experience the greatest emotions.

How can we make these moments even more pleasant for you? We can give you the most comfortable sofa, the one you exactly need. This is the furniture we create. First, we take a look at your needs to be able to design furniture which satisfies the tastes of even the most demanding customers. We take a long time to test our products and be sure that everything is all right. We take care of the smallest details to make you satisfied with every single look at the sofa, every single touch of the fabric and the pleasure of sinking into the cushions. That's what is truly important is your own pleasure. Choose your perfect sofa.

*That's what is truly important is your own pleasure.
Choose your perfect sofa.*

Anton

Anton has been designed to surprise you with comfort. A combination of proper springs and highly elastic foam in the seat and a proper silicone mixture used as the cushion in-fill make you find it simply irresistible to sit on this piece of furniture every time you walk by. Its harmonious, slightly rounded shapes and narrow sides will perfectly match interiors of various styles.

3-SEATER



CORNER SET 1, RIGHT



Design by Noboo Studio

2-SEATER

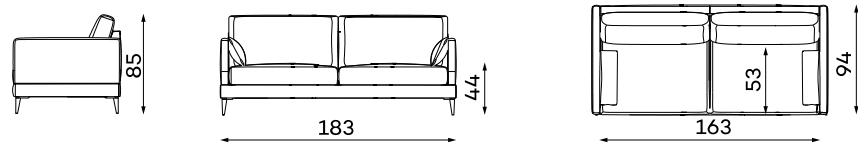

3-SEATER

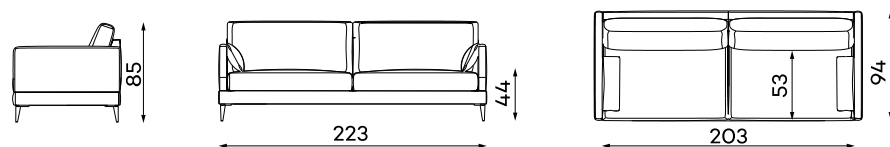

ARMCHAIR

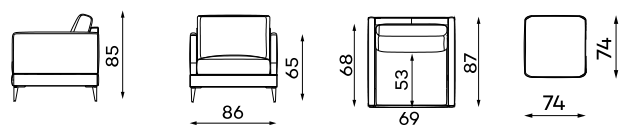

POUF

SET 1

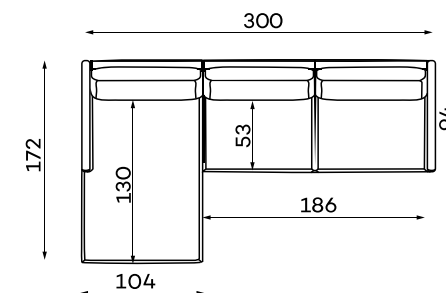

OTHER DIMENSIONS

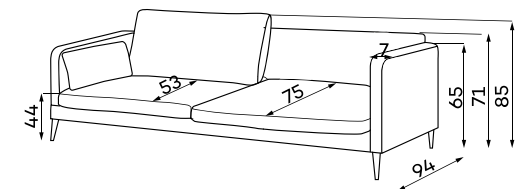

All corners and modules can be ordered with either a left or right-hand layout. All figures shows the left-hand side.

Size tolerance for upholstered furniture +/- 4 cm. All dimensions and configurations of furniture can be found at www.befame.com

kt. NABOO STUDIO



Belavio

4-SEATER



SOFA RELAX



Belavio is recommended for persons looking for distinguished furniture emphasizing an unusual style of their interior. Its comfortable and soft quilted seats, special wrinkled effects, external cross-stitchings and high metal legs contribute to the very unique style. It is perfect for those who look for courageous designer solutions and hate boredom at home.

3-SEATER WITH SLEEPING FUNCTION



Design by Fanajto Home Design Decor

SOFA RELAX

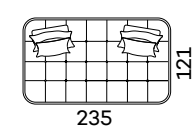

2-SEATER

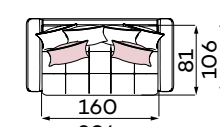

3-SEATER

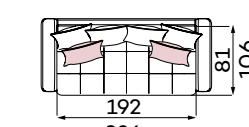

4-SEATER

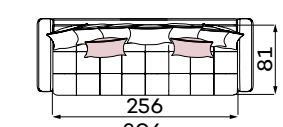

3-SEATER WITH SLEEPING FUNCTION

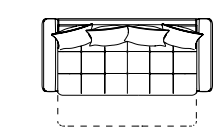

SLEEPING AREA
198 x 145 cm

CHAISE LONGUE S

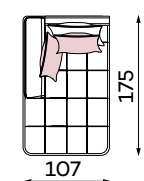

CHAISE LONGUE M

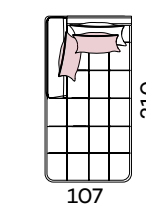

SMALL POUFFE

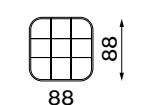

BIG POUFFE

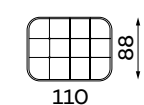

BELAVIO POUFFE

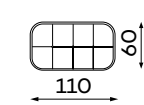

OTHER DIMENSIONS

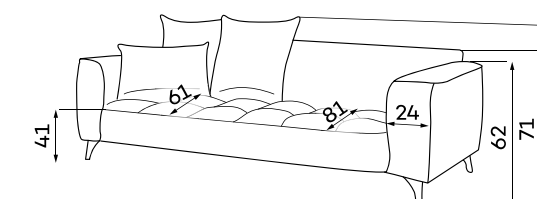

All corners and modules can be ordered with either a left or right-hand layout. All figures shows the left-hand side.

Size tolerance for upholstered furniture +/- 4 cm. All dimensions and configurations of furniture can be found at www.befame.com



CORNER SET 1, RIGHT



CORNER SET 3 WITH SLEEPING FUNCTION, RIGHT



Design by Art'Up
Photo by ŁAD Studio

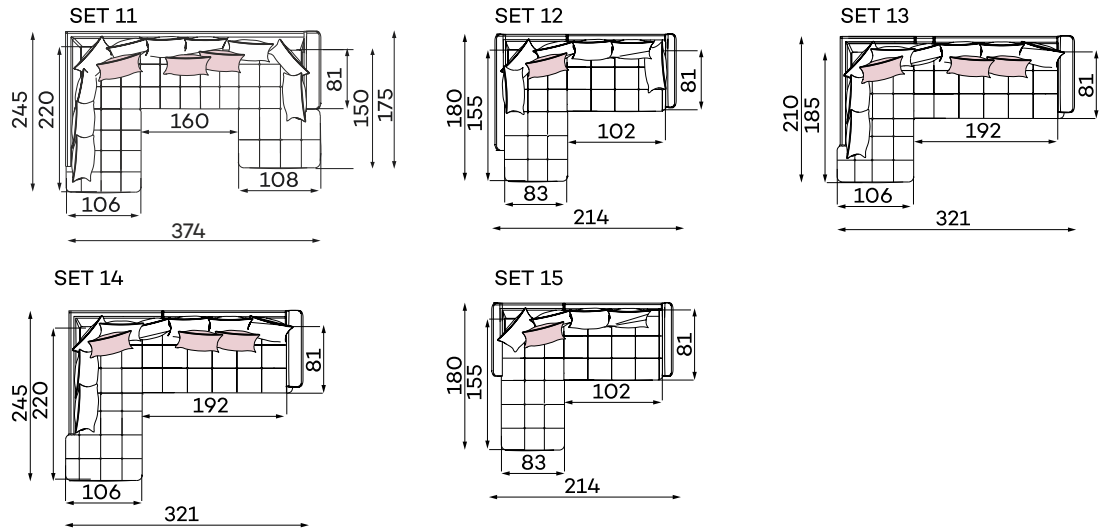
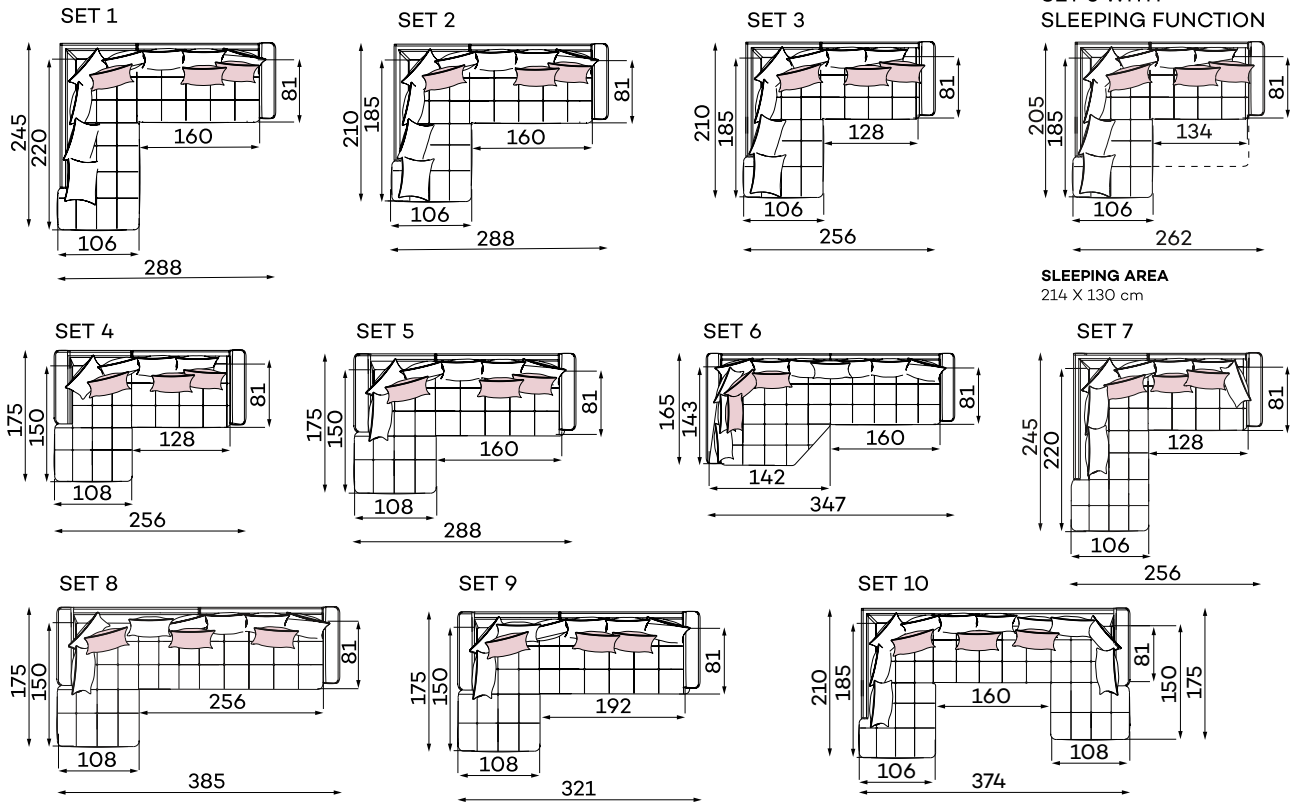

All corners and modules can be ordered with either a left or right-hand layout.
All figures shows the left-hand side.

Size tolerance for upholstered furniture +/- 4 cm.
All dimensions and configurations of furniture can be found at www.befame.com



BED 180



BED 140

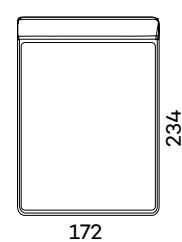

SLEEPING AREA
140 x 200 CM
HEIGHT OF THE HEADREST
118 CM

BED 160

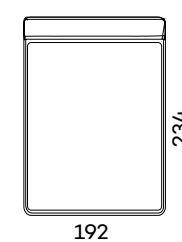

SLEEPING AREA
160 x 200 CM
HEIGHT OF THE HEADREST
118 CM

BED 180

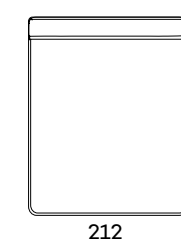

SLEEPING AREA
180 x 200 CM
HEIGHT OF THE HEADREST
118 CM

BED 200

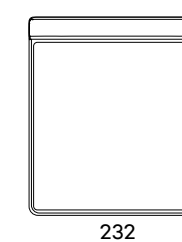

SLEEPING AREA
200 x 200 CM
HEIGHT OF THE HEADREST
118 CM

All corners and modules can be ordered with either a left or right-hand layout.
All figures shows the left-hand side.

Size tolerance for upholstered furniture +/- 4 cm.
All dimensions and configurations of furniture can be found at www.befame.com



Bellissa

Bellissa is the undisputed queen of the interior, perfect for those who are not afraid of bold design and distinctive details. Does that match you? Look at these characteristic creases - they give a glamorous look in combination with velour material and decorated, high legs. Soft, spacious seat cushions filled with a special silicone compound and loose back cushions are a promise of rest and relaxation. It is, in a word, so unique that cannot be left unnoticed. Going to take it home?

2-SEATER



2-SEATER

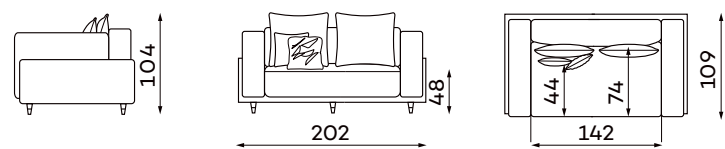

3-SEATER

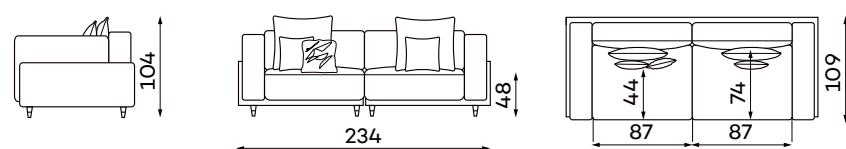

4-SEATER

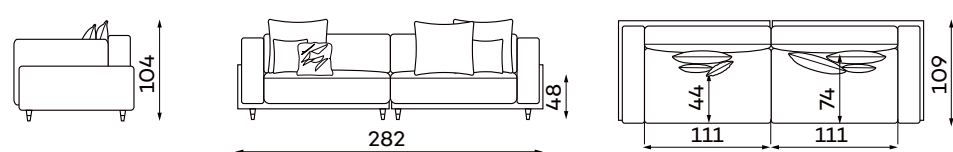

SMALL POUFFE

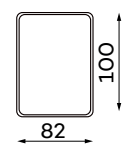

BIG POUFFE

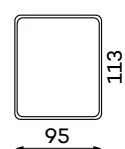

BELLISSA POUFFE

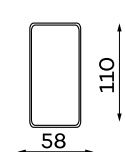

4-SEATER



All corners and modules can be ordered with either a left or right-hand layout. All figures shows the left-hand side.

Size tolerance for upholstered furniture +/- 4 cm. All dimensions and configurations of furniture can be found at www.befame.com



CORNER SET 2, LEFT



CORNER SET 1, LEFT



Design by Polilinia Design

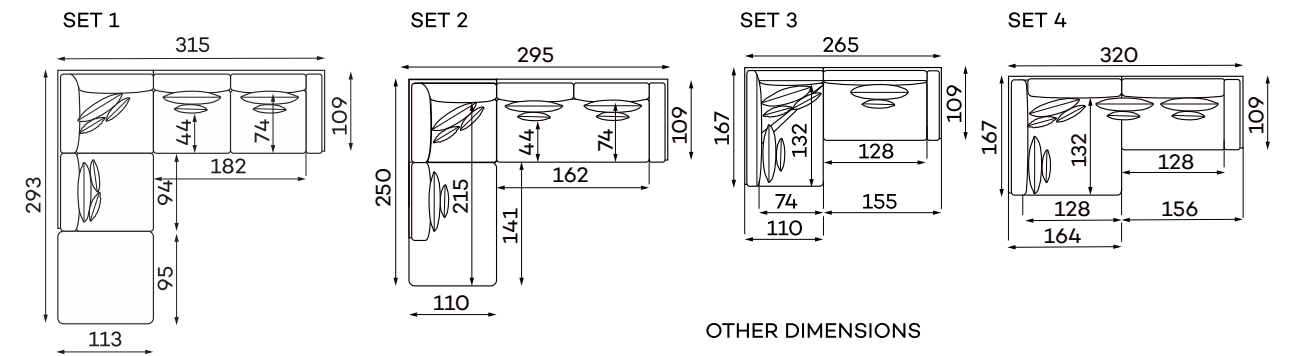
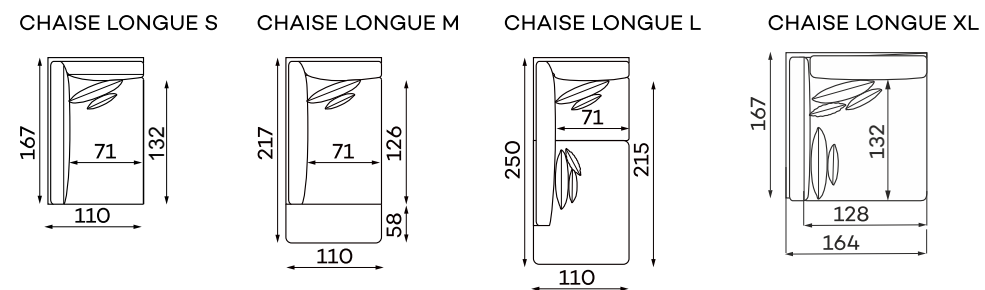
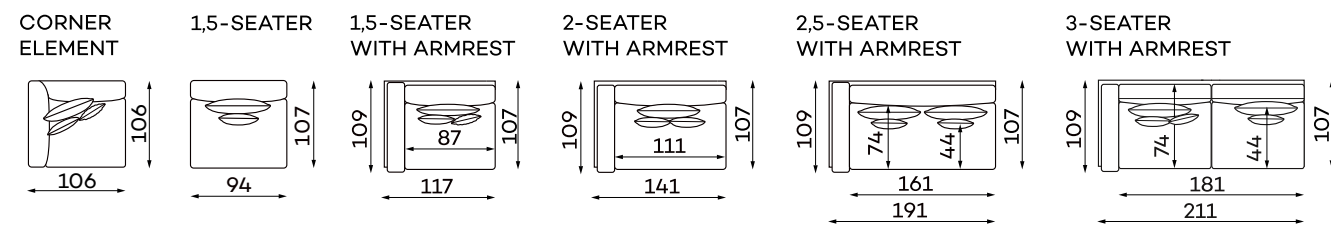

OTHER DIMENSIONS

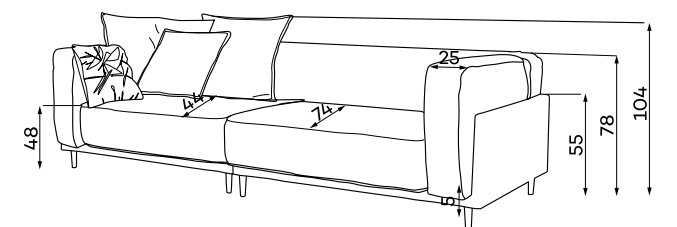

All corners and modules can be ordered with either a left or right-hand layout. All figures shows the left-hand side.

Size tolerance for upholstered furniture +/- 4 cm. All dimensions and configurations of furniture can be found at www.befame.com



Bullet

Imagine a simple and modern style interior with an eye-catching accent - the Bullet corner sofa. It is easy to fall in love with these exceptional and rounded shapes, all the more so that the combination of an excellent quality wave springs and highly elastic foam along with adjustable headrests make this furniture amazingly comfortable in use. The additional advantages include the sleeping function and a bedding compartment.



CORNER SET 1, LEFT

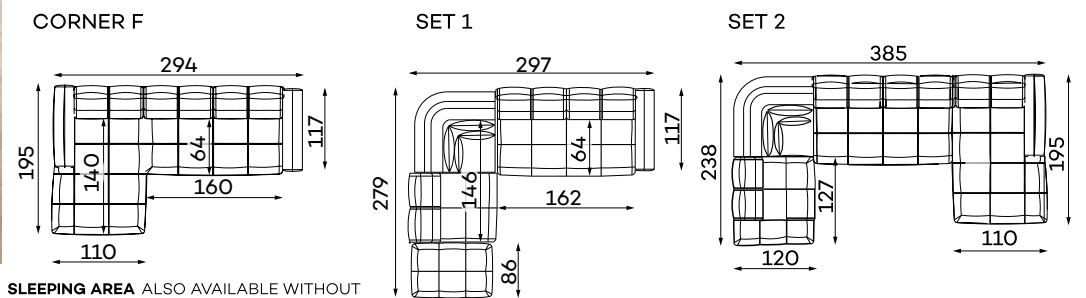

SLEEPING AREA ALSO AVAILABLE WITHOUT
240 x 137 CM SLEEPING FUNCTION

ADJUSTABLE HEADRESTS

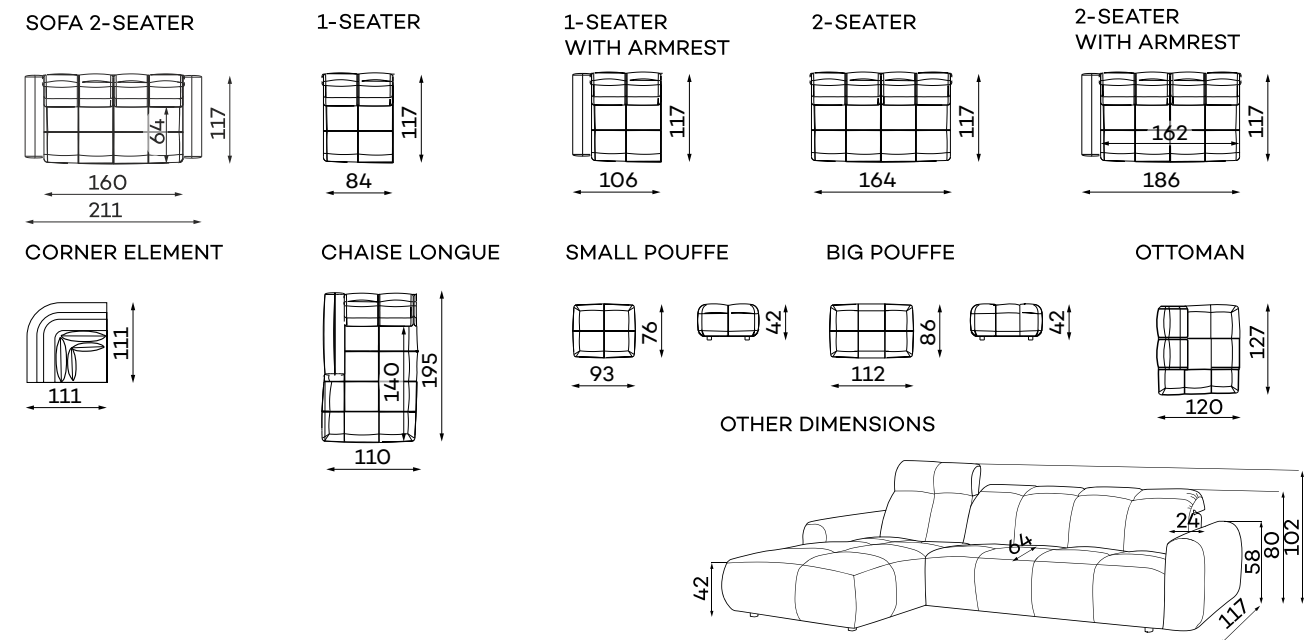

All corners and modules can be ordered with either a left or right-hand layout. All figures shows the left-hand side.

Size tolerance for upholstered furniture +/- 4 cm. All dimensions and configurations of furniture can be found at www.befame.com



Carmen

Carmen is a romantic model. Its romantic nature is created by the charming, wavy borders on the cushions. It has a unique property - its sides are movable and adjustable, letting you relax comfortably in a sitting or half-lying position. These are not all advantages - this model is equipped with a sleeping function which lets you take a rest in your preferable position

3-SEATER WITH SLEEPING FUNCTION



3-SEATER

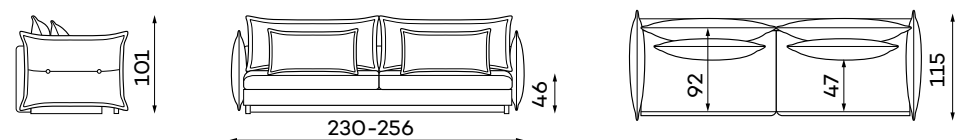

SLEEPING AREA
198 x 160 CM

4-SEATER

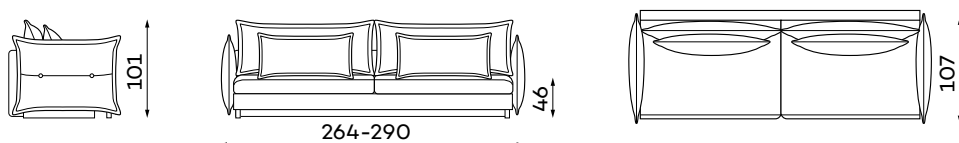

NO SLEEPING AREA

OTHER DIMENSIONS

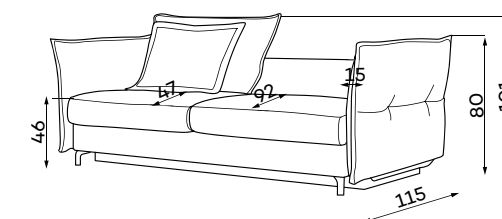

All corners and modules can be ordered with either a left or right-hand layout.
All figures shows the left-hand side.

Size tolerance for upholstered furniture +/- 4 cm.
All dimensions and configurations of furniture can be found at www.befame.com



CORNER SET 3 WITH SLEEPING FUNCTION, RIGHT



CORNER SET 1 WITH SLEEPING FUNCTION, RIGHT



ADJUSTABLE SIDES

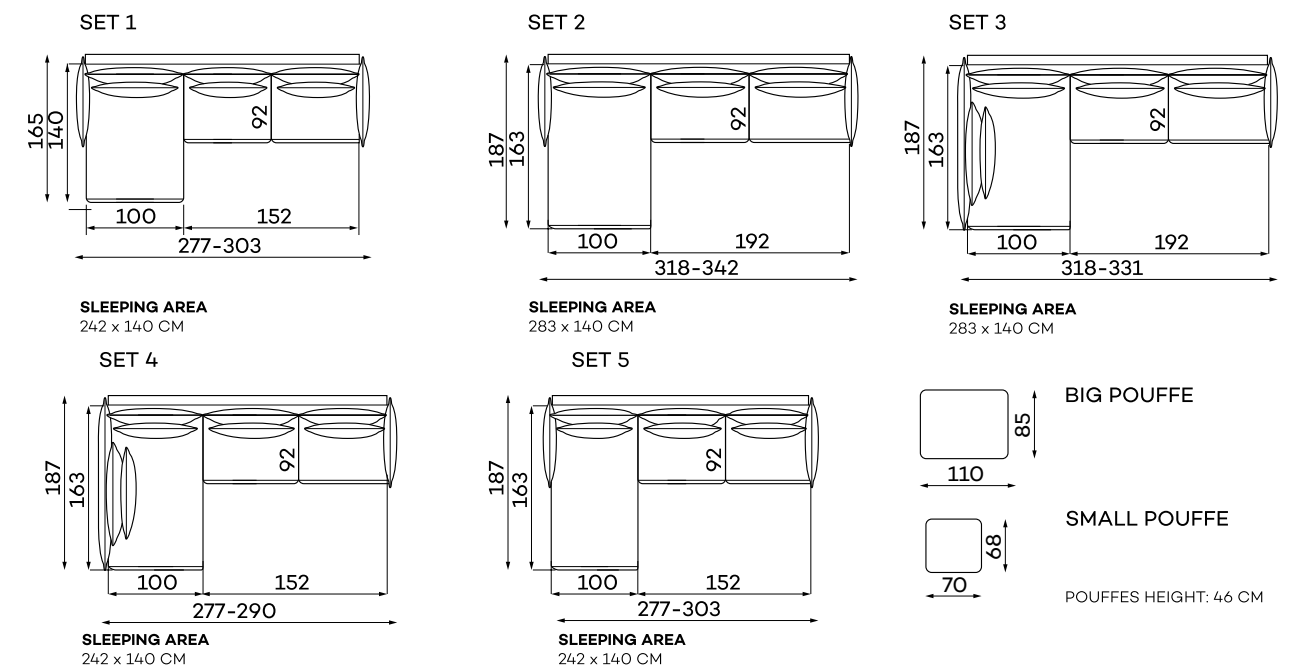

All corners and modules can be ordered with either a left or right-hand layout. All figures shows the left-hand side.

Size tolerance for upholstered furniture +/- 4 cm. All dimensions and configurations of furniture can be found at www.befame.com

Corrado

Corrado is an alternative to the Rio model - it is also a modular model that you can configure to your needs. Just as soft, thanks to the combination of two types of high-elastic foam in the seat structure and silicone down filling the backrest cushions. The pleasant sinking sensation does not result in the deformation of the furniture, the form of which remains unchanged for a long time. The distinguishing feature of this model is an interesting, inverted trim, for which we have carefully selected the appropriate fabrics to guarantee a unique result.

4-SEATER



CORNER, LEFT

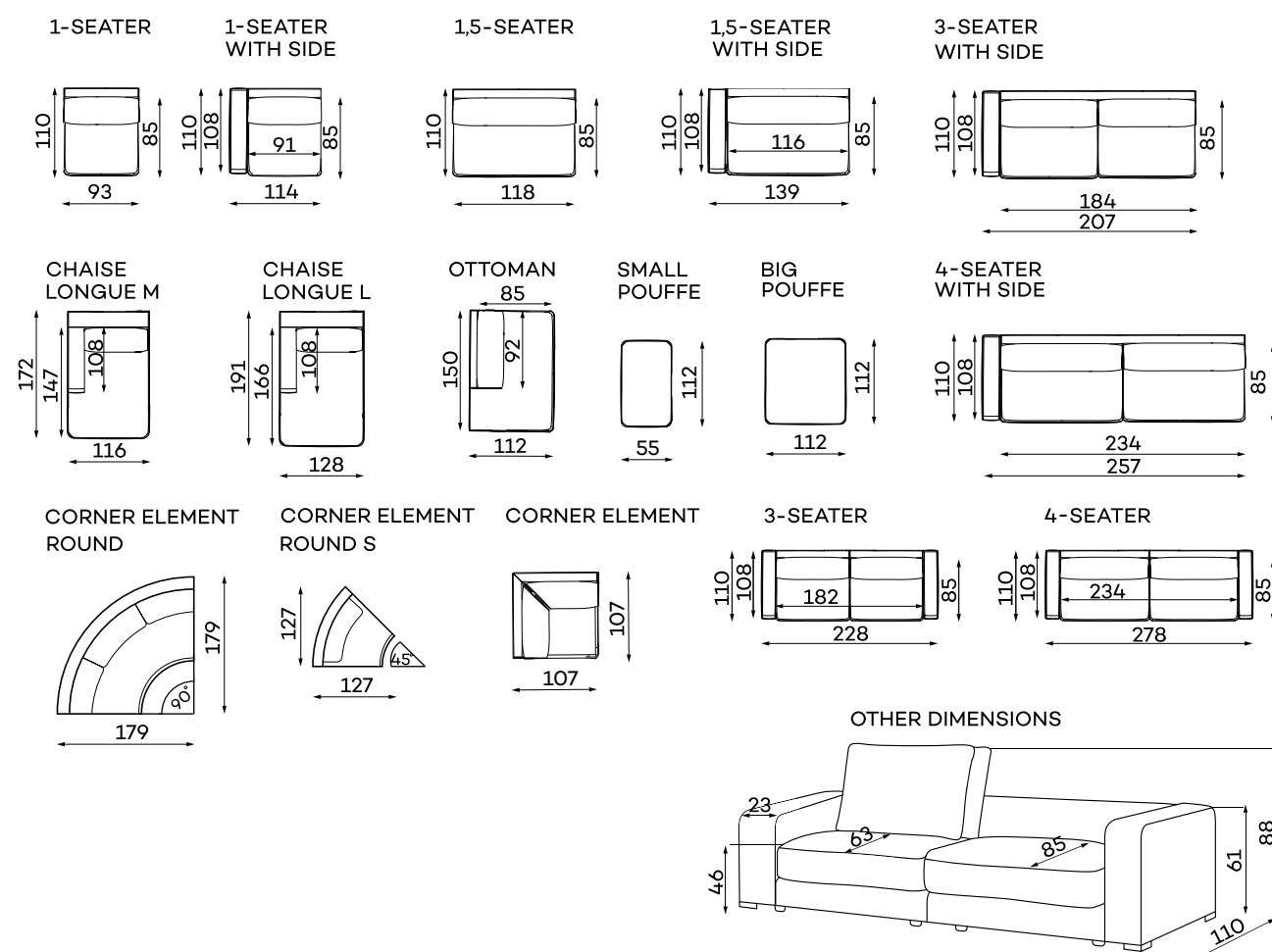

All corners and modules can be ordered with either a left or right-hand layout. All figures shows the left-hand side.

Size tolerance for upholstered furniture +/- 4 cm. All dimensions and configurations of furniture can be found at www.befame.com

Domani

Domani is a modern and very pleasant rounded model, consisting of straight and bean-shaped modules. By combining them freely you can create a fanciful shape: a sofa, an L-shaped corner sofa, but also a semi-circle, an open circle, a wave or an S-shape. You are only limited by your imagination! This unique feature makes Domani suitable for a wide variety of rooms – from a cosy living room to an exclusive waiting room in a clinic. Because sometimes we expect furniture to help us be very close to someone, and sometimes we can use it together with others to preserve some intimacy. Interesting? Finally, a little hint – this model looks fantastic in boucle fabrics!



Design by We wnętrzu

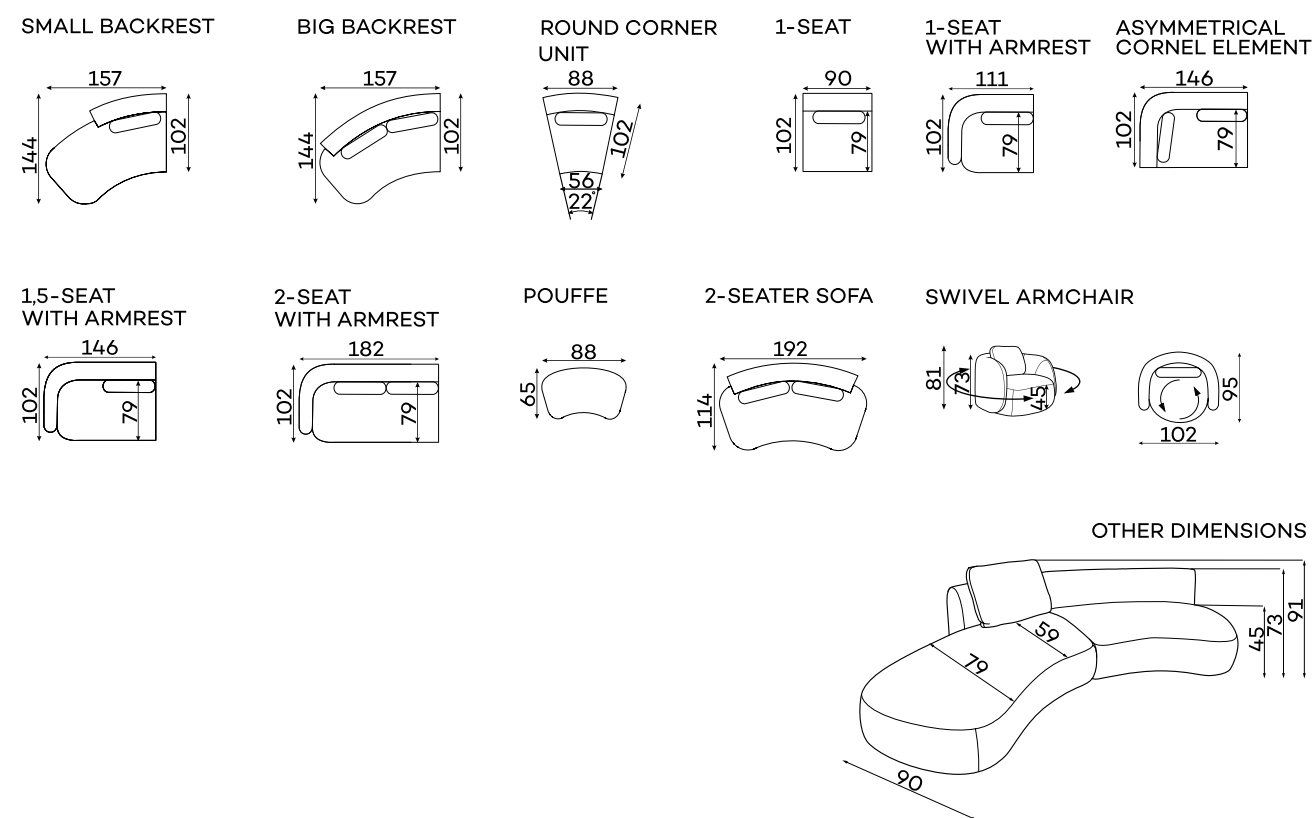

SET 1, LEFT



All corners and modules can be ordered with either a left or right-hand layout. All figures shows the left-hand side.

Size tolerance for upholstered furniture +/- 4 cm. All dimensions and configurations of furniture can be found at www.befame.com



Design by Izabela Bielecka

SWIVEL ARMCHAIR



SET 4

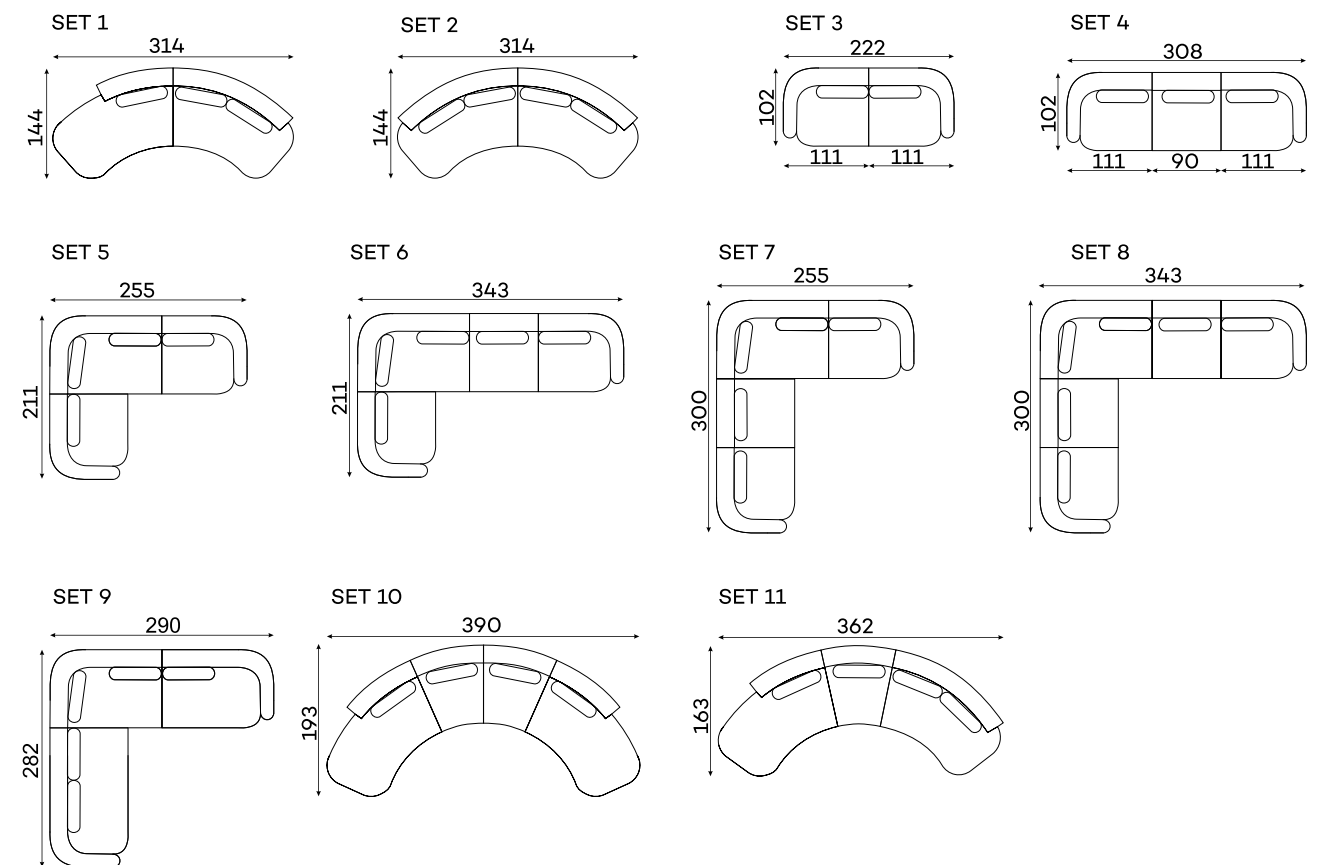

All corners and modules can be ordered with either a left or right-hand layout. All figures shows the left-hand side.

Size tolerance for upholstered furniture +/- 4 cm. All dimensions and configurations of furniture can be found at www.befame.com



Dune

A unique sofa with its irregular, curved shape, available in a 2, or 3-seater version, allows for an interesting arrangement of different types of space, from an apartment to a hotel lobby. The soft yet springy seat is suitable for those who don't like to fall into the sofa but instead value comfort. Dune, therefore, is a deep, comfortable seat with additional cushions that make it suitable for people of different heights. We suggest that in a long-pile fabric, resembling rabbit fur, it looks especially charming.

2-SEATER



3-SEATER

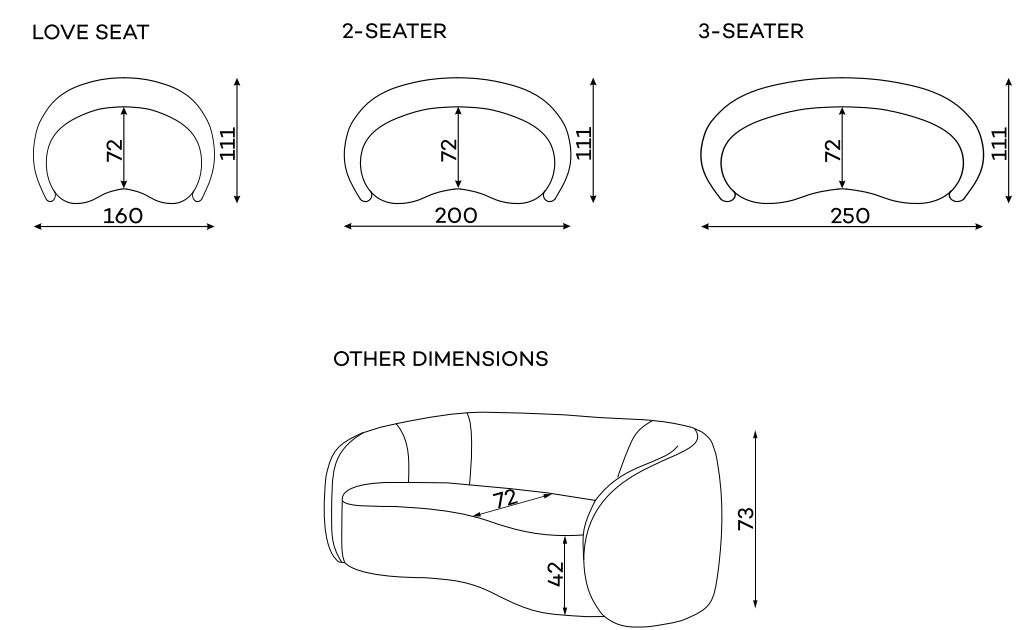

All corners and modules can be ordered with either a left or right-hand layout. All figures shows the left-hand side.

Size tolerance for upholstered furniture +/- 4 cm. All dimensions and configurations of furniture can be found at www.befame.com

Foggia

Foggia is a modular proposal that allows a wide variety of configurations, from a small sofa to a very large corner. It is particularly well suited for interiors decorated in a modernist, modern style. The simple shape encourages a little madness in choosing the fabric, an original pattern or trim in a different colour will be an interesting variety. Foggia is the comfort of a stable seat, soft but springy.

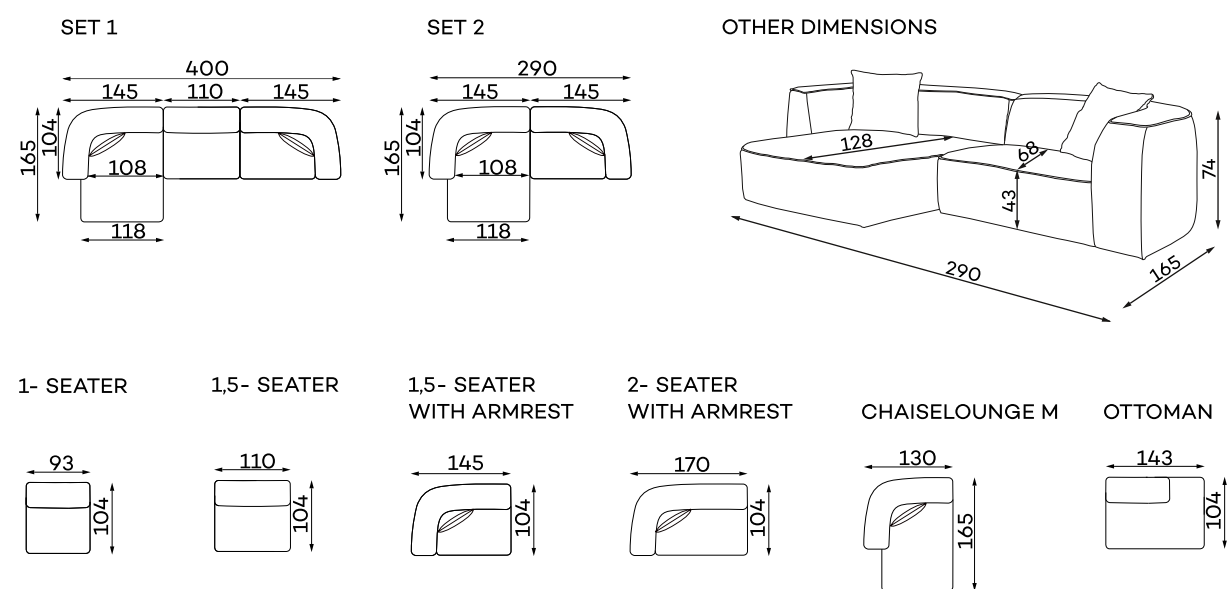

All corners and modules can be ordered with either a left or right-hand layout.
 All figures shows the left-hand side.

Size tolerance for upholstered furniture +/- 4 cm.
 All dimensions and configurations of furniture can be found at www.befame.com

Laurent

Laurent is Bellissa's younger brother – just like her it is made of modules, it also has soft and very comfortable seat cushions, thanks to a special combination of corrugated springs and highly flexible foam. Just by looking at it, you can imagine the comfort of resting on this piece of furniture. You can comfortably sit back and enjoy aromatic coffee and admire the views outside the window, or lie down under a warm blanket, accompanied by your favourite book or film. Laurent is slightly more versatile in style, making it easier to fit into various types of interiors. Its charm is enhanced by a decorative trim and loose decorative pillows.



CORNER SET 2, LEFT

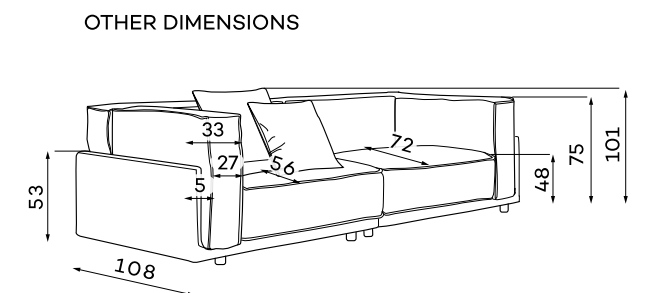
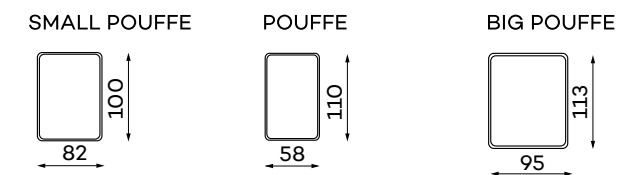
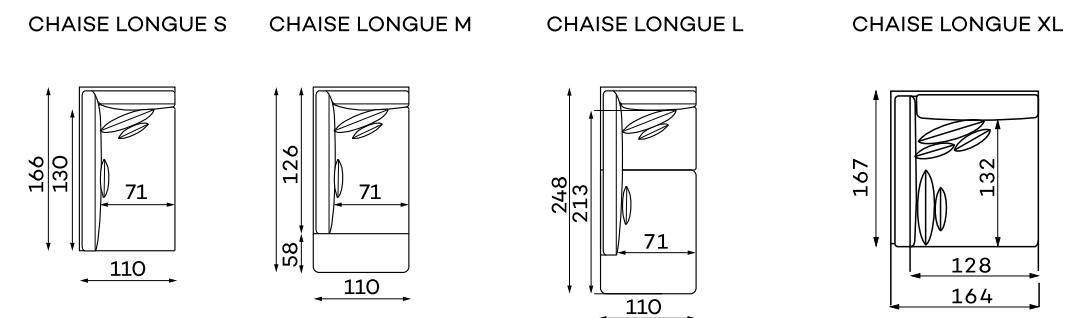
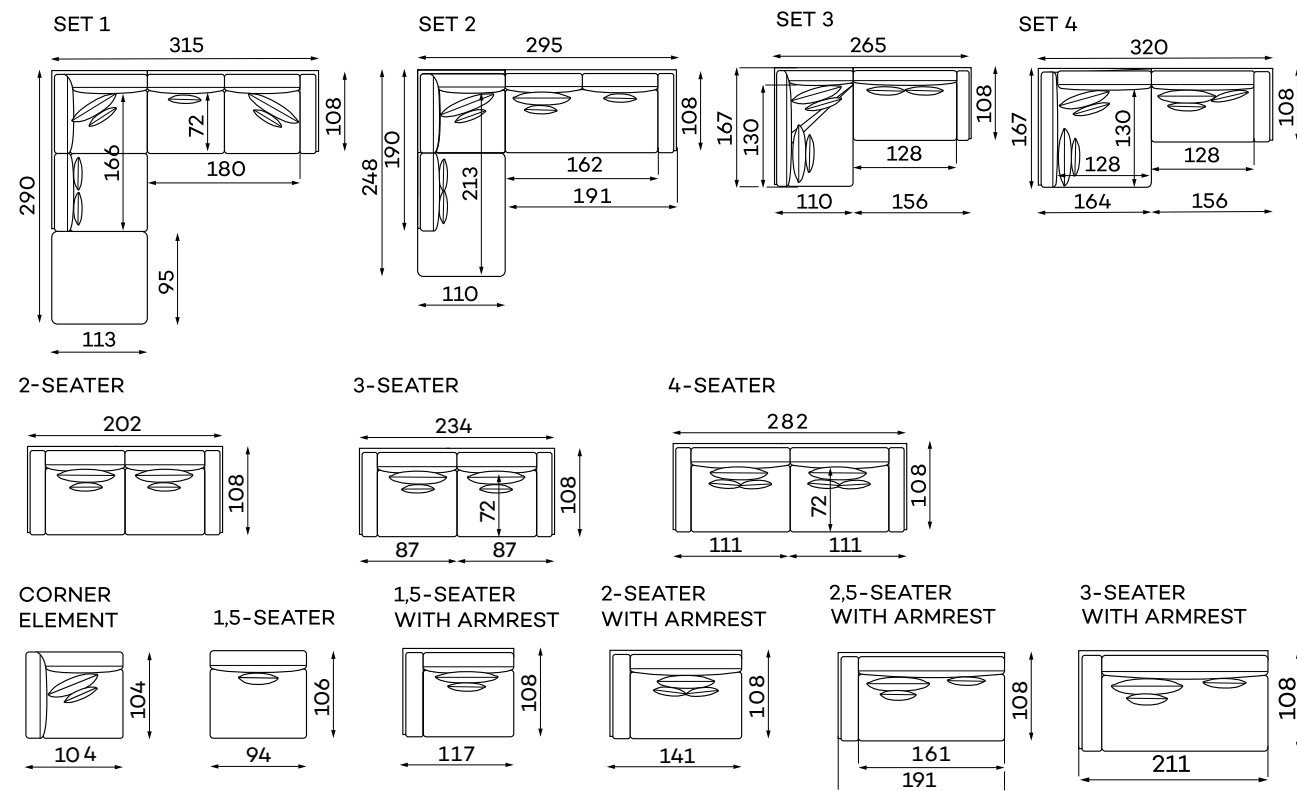

All corners and modules can be ordered with either a left or right-hand layout. All figures shows the left-hand side.

Size tolerance for upholstered furniture +/- 4 cm. All dimensions and configurations of furniture can be found at www.befame.com

Lua

Lua is a simple, classic form that blends perfectly into modern, often minimalist interiors. Just a little imagination is enough to create furniture that also matches the character of other interior styles. Simply choose an extraordinary fabric to create from a variety of custom modules to suit your individual needs to achieve a completely different effect. It's a matter of design, and a matter of ergonomics and comfort – we've made sure that the Lua model is the epitome of these. The wide and soft backrest and seat cushions let you sink into relaxation while reading your favourite book or watching a movie. All you have to do is choose – a small sofa or maybe an elaborate corner sofa?

CORNER, RIGHT



INT
DESIGN

Design by INT Design

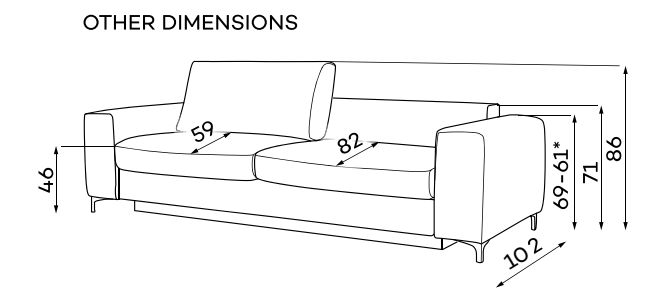
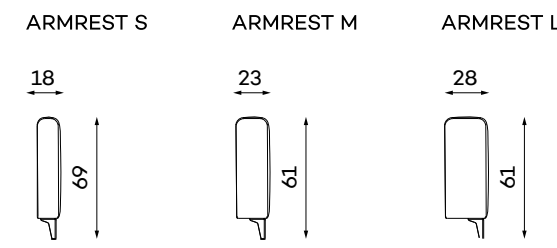
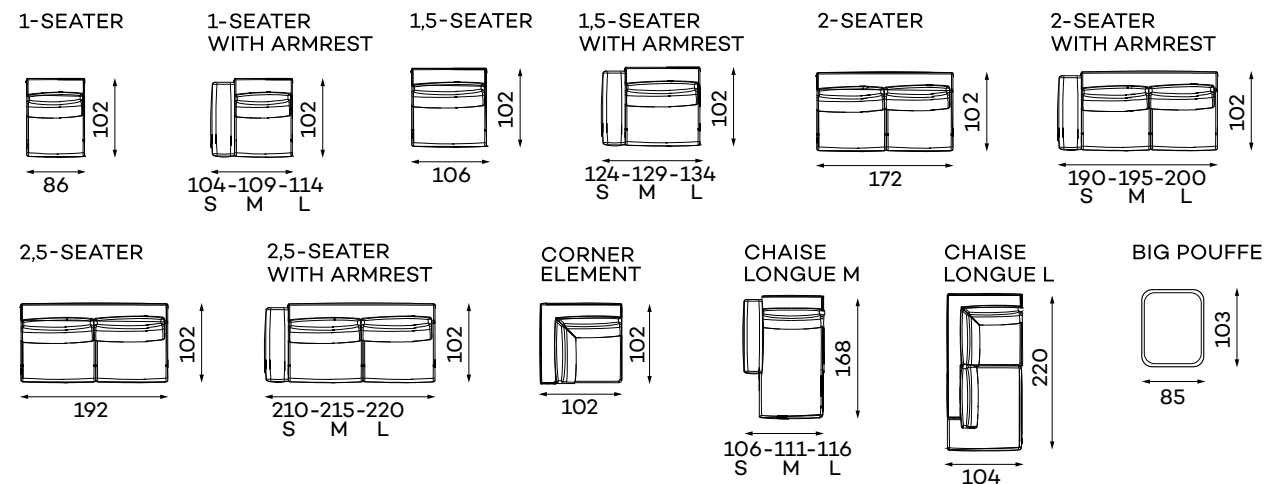

All corners and modules can be ordered with either a left or right-hand layout. All figures shows the left-hand side.

Size tolerance for upholstered furniture +/- 4 cm. All dimensions and configurations of furniture can be found at www.befame.com

Lust

The idea behind the creation of the Lust model was to create a sofa that, although it is not visible at first glance, has a relaxation function. Why invisible? Because the furniture remains perfectly proportional, regular and pleasant for the eye. It is a modular model, so you can compose the size and shape of the module as desired by deciding whether or not the module is equipped with electrical features: Relaxation and/or the adjustment of the head rests. The comfort is enhanced by the very shape of the sofa – wide and deep as well as the filling which consists of a special composition of high-elastic foams, lazy foams and quilts filled with silicone down. In short, top-of-the-range comfort for the body and a feast for the eye, because regardless of the selected modules, it looks exceptionally harmonious and soft, yet unconventional.

LUST SET 1 CORNER, LEFT



LUST SET 1 CORNER ELECTRIC RELAX, LEFT



SET 1 ELECTRIC

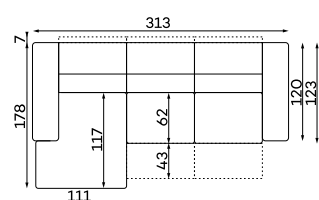

1-SEATER ELECTRIC HEADREST

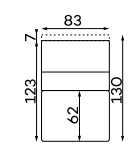

1-SEATER WITH ARMREST ELECTRIC HEADREST

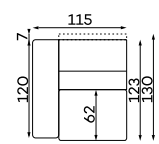

CHAISELOUNGE ELECTRIC HEADREST

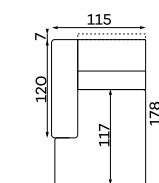

1-SEATER FULL ELECTRIC

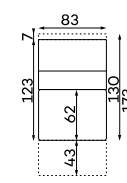

1-SEATER WITH ARMREST FULL ELECTRIC

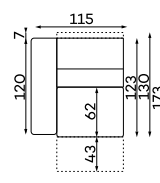

SET 1 MANUAL

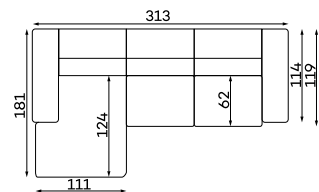

CHAISE LONGUE

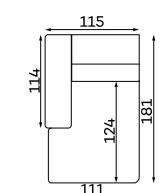

1-SEATER

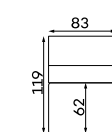

1-SEATER WITH ARM

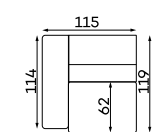

CORNER ELEMENT

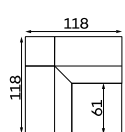

OTHER DIMENSIONS MANUAL

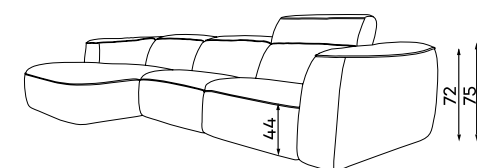

OTHER DIMENSIONS ELECTRIC

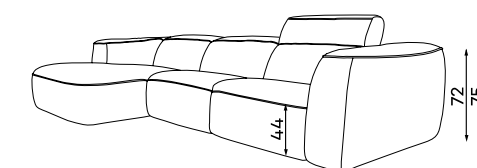

All corners and modules can be ordered with either a left or right-hand layout. All figures shows the left-hand side.

Size tolerance for upholstered furniture +/- 4 cm. All dimensions and configurations of furniture can be found at www.befame.com

Moon

Moon is a product designed to satisfy those who prefer simple and classic forms. However, do not let the first impression mislead you – it is not an ordinary piece of furniture, many of which are available around. We have spent many hours to refine details, especially to adjust proportions and provide you with the best ergonomics of use. That is why it comes with wide and soft seat and backrest cushions or broad sides designed to give you a proper support.



3-SEATER WITH SLEEPING FUNCTION, ARMREST L



Desing by Pololinia Desing

3-SEATER
ARMREST S

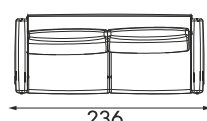

SLEEPING AREA
198 x 148 cm

3-SEATER
ARMREST M

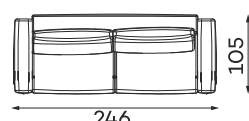

SLEEPING AREA
198 x 148 cm

3-SEATER
ARMREST L

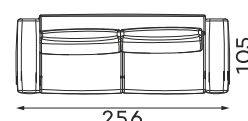

SLEEPING AREA
198 x 148 cm

ARMREST S

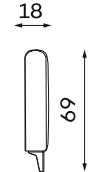

ARMREST M

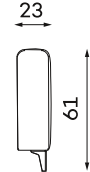

ARMREST L

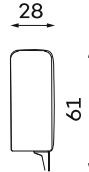

OTHER DIMENSIONS

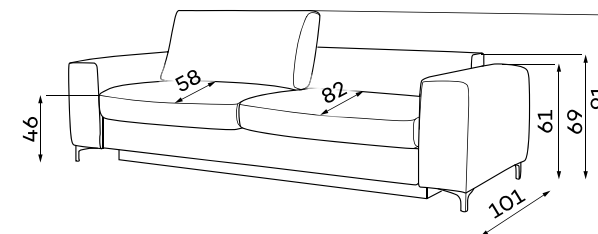

SMALL POUFFE



BIG POUFFE

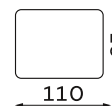

POUFFE HEIGHT; 46

All corners and modules can be ordered with either a left or right-hand layout.
All figures shows the left-hand side.

Size tolerance for upholstered furniture +/- 4 cm.
All dimensions and configurations of furniture can be found at www.befame.com

CORNER SET 1 WITH SLEEPING FUNCTION ARMREST M, LEFT



CORNER SET 2 WITH SLEEPING FUNCTION ARMREST L, LEFT



SET 1

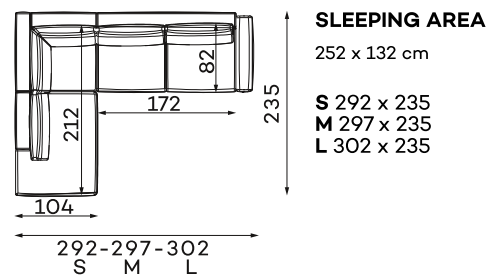

SET 2

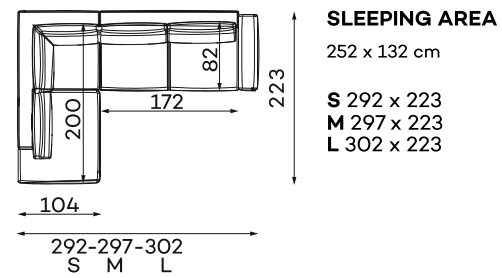

SET 3

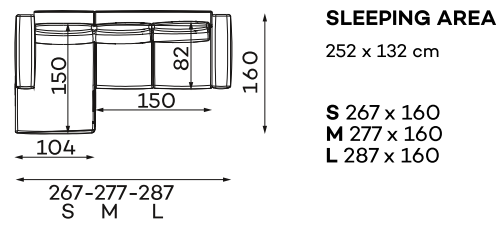

SET 4

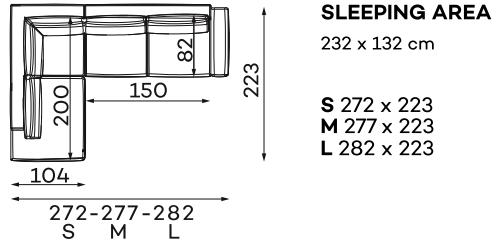

ARMREST S ARMREST M ARMREST L

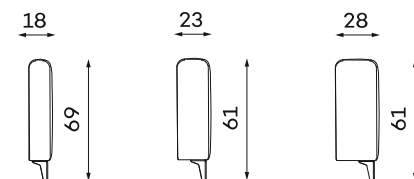

CORNER SET 3 ARMREST M, RIGHT



All corners and modules can be ordered with either a left or right-hand layout.
All figures shows the left-hand side.

Size tolerance for upholstered furniture +/- 4 cm.
All dimensions and configurations of furniture can be found at www.befame.com

Rio

Close your eyes and sit down. Don't you feel like being on a soft and delicate cloud? This is how the Rio sofa owners most often speak of it. You can pleasantly "sink into" it thanks to the combination of two special highly elastic foams and silicone down which offers the same feeling as natural feathers, but is friendly to people with allergies and resistant to deformations often referred to as „sagginess“.



NARROW SIDE

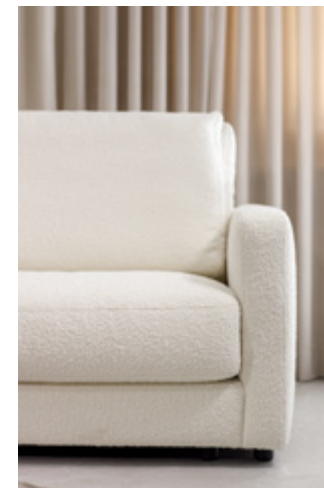

WIDE SIDE



SET 6 WIDE SIDE, LEFT



SET 9 NARROW SIDE, LEFT



All corners and modules can be ordered with either a left or right-hand layout.
All figures shows the left-hand side.

Size tolerance for upholstered furniture +/- 4 cm.
All dimensions and configurations of furniture can be found at www.befame.com

Rio

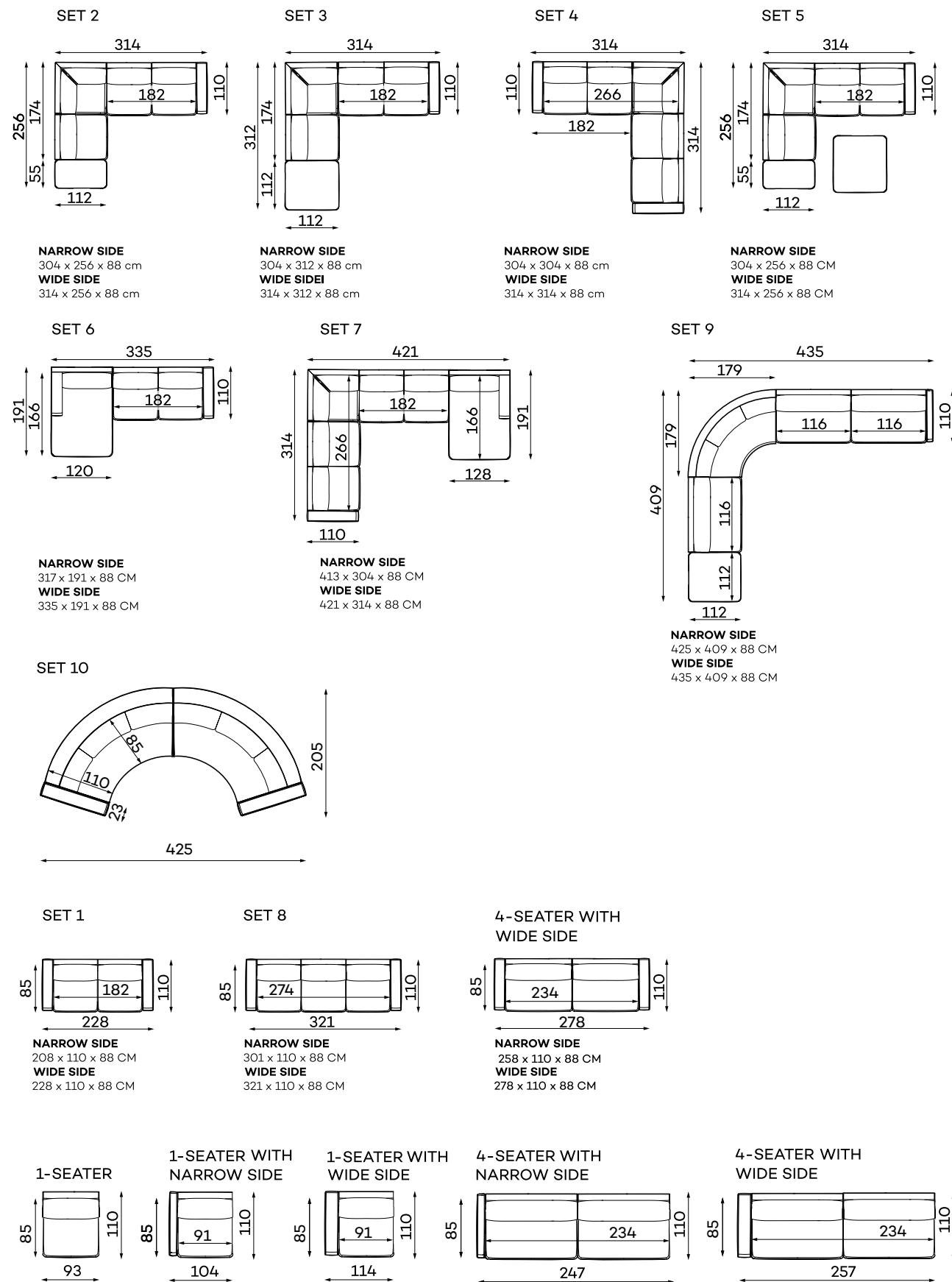

Rio

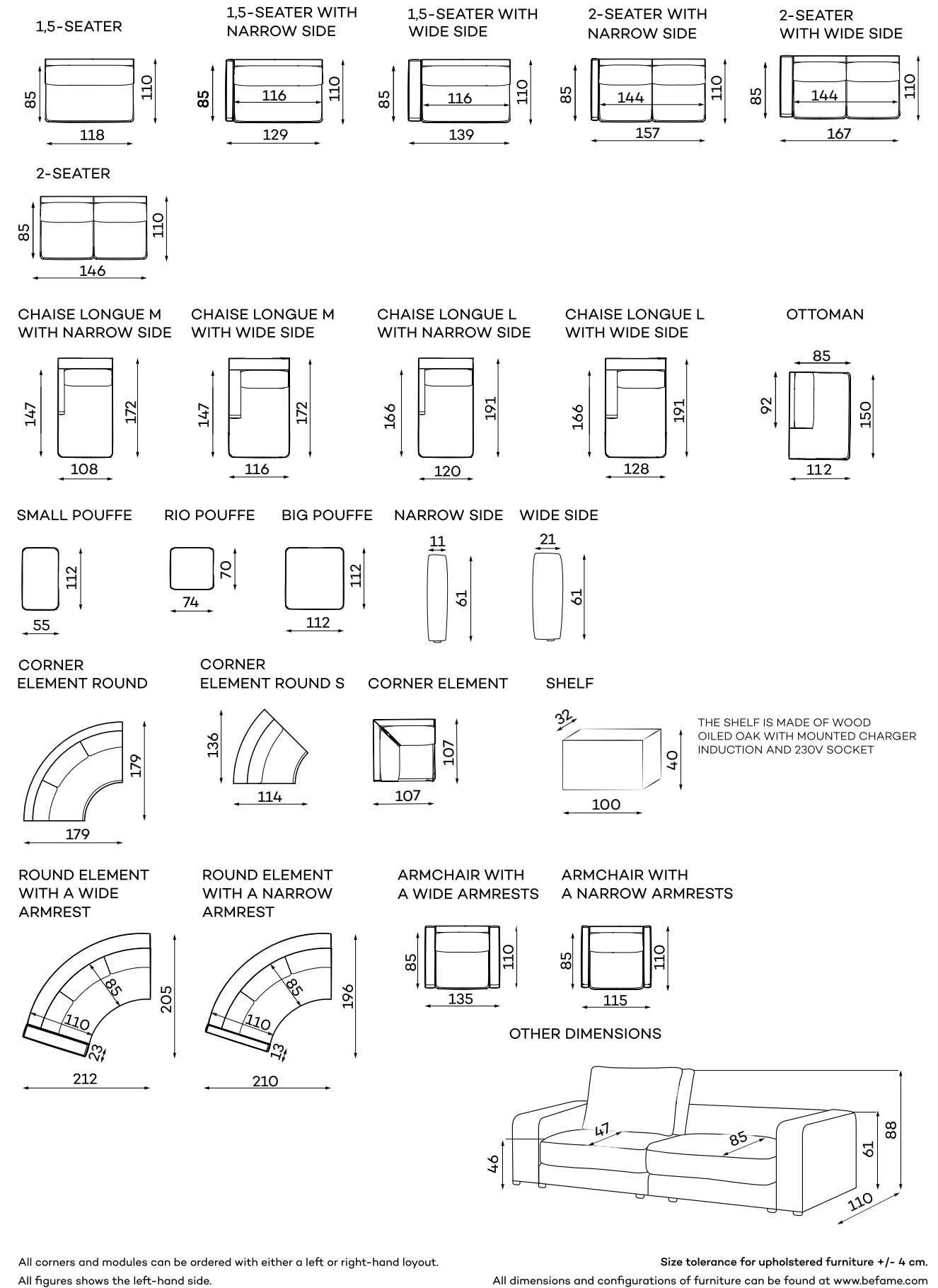



Soprano

Looking for sofas that are visually light and modern, but don't want to compromise on your comfort? Soprano is a great choice. The tall metal feet and streamlined shape are in keeping with the latest trends, but the biggest advantage of this model is its softness, thanks to the combination of two types of high-elastic foams with silicone down and a wave-spring design. In addition to exceptional comfort, we guarantee your satisfaction of use - even after a long period of use, the sofas will return to their original shape, and allergy sufferers do not have to worry about the conditions that occur often when the filling is made from natural feathers. Choose from a wide range of fabrics and sizes of sofas and enjoy a pleasant moment of relaxation on your home.

4-SEATER



CORNER, LEFT

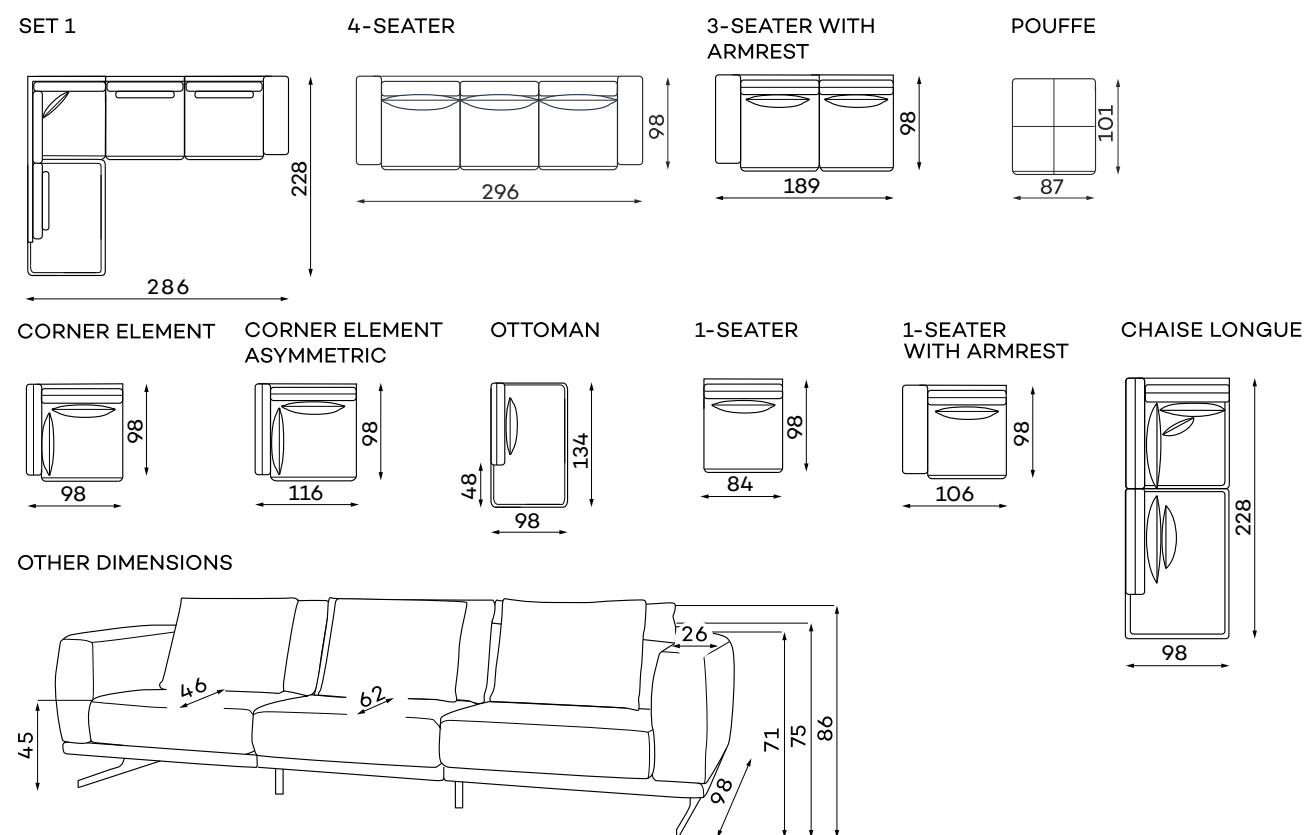

All corners and modules can be ordered with either a left or right-hand layout. All figures show the left-hand side.

Size tolerance for upholstered furniture +/- 4 cm. All dimensions and configurations of furniture can be found at www.befame.com

Do you like the back rest designed for you to comfortably lean your head on it or do you prefer when it is slightly bent backwards? Or do various members of your family have different expectations here? The Tivoli corner sofa will meet all these requirements. You can freely adjust its back rest with a quick and convenient system. This comes with a streamlined shape and soft in-fill in seats, enriched with a quilt made of anti-allergic silicone down - the best of harmony and everyday relaxation in the modern style.

CORNER SET 1, RIGHT



ADJUSTABLE HEADRESTS

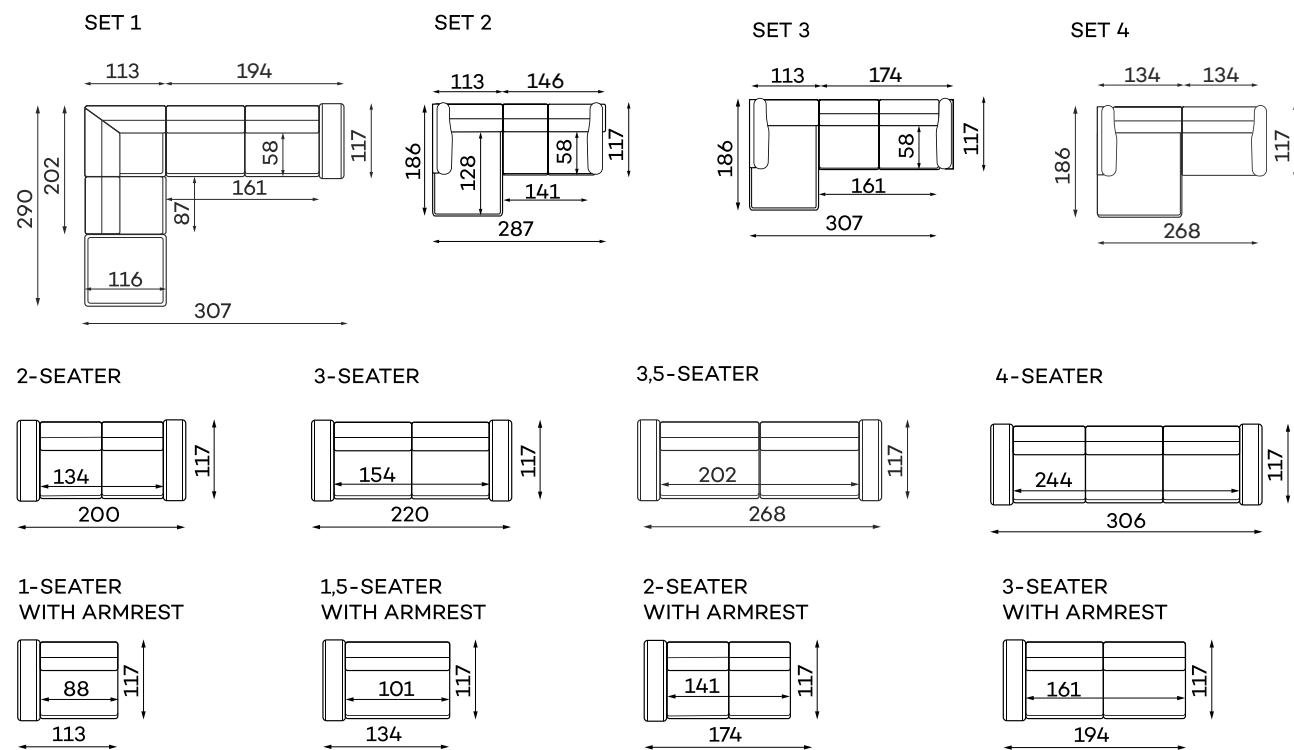

All corners and modules can be ordered with either a left or right-hand layout. All figures shows the left-hand side.

Size tolerance for upholstered furniture +/- 4 cm. All dimensions and configurations of furniture can be found at www.befame.com

Tulia

Tulia is an interesting proposal, which can be a sofa, a smaller corner if we use a chaise longue or a larger one if you additionally incorporate a pouffe. You decide. As usual, we have ensured exceptional comfort – a soft yet resilient seat and a suitably contoured backrest, movable sides and an extra armrest that can be positioned exactly where you need it. And the look? In no way inferior to comfort! The high legs, available in several colours, add lightness to the shape and the fleshy trim adds charm. The advantage is also the interesting wrinkles formed in various places as a result of dragging your hand – the right choice of fabric will allow there to be more or less of them, depending on your preference.



SET 1

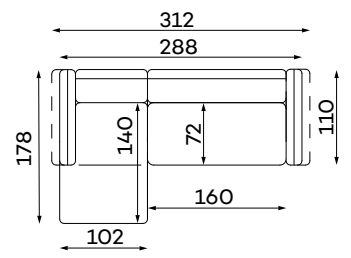

SET 2

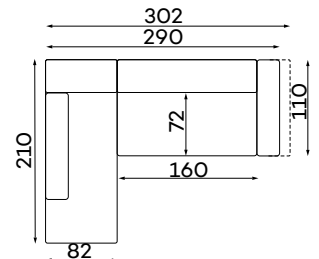

POUFFE

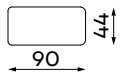

OTHER DIMENSIONS

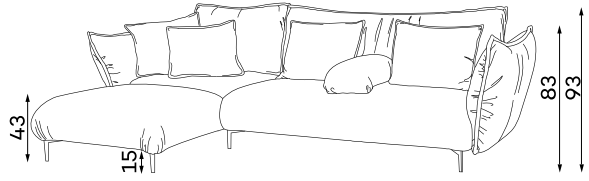

CORNER SET 1, LEFT



All corners and modules can be ordered with either a left or right-hand layout. All figures shows the left-hand side.

Size tolerance for upholstered furniture +/- 4 cm. All dimensions and configurations of furniture can be found at www.befame.com

Armchair

A fire in a fireplace or the glow of candles, a cup of your favourite tea, an inspiring book and... what is missing from this picture? Of course, a comfortable armchair! The softness is obtained thanks to the high-quality foam of the highly flexible, guarantees your comfort even when you're going to sit for a little longer. There's no need to wait - choose the right fabric, one of the four colours of the feet and enjoy your own relaxing, most comfortable place to relax.



LUNGO



ILA



ARMCHAIR

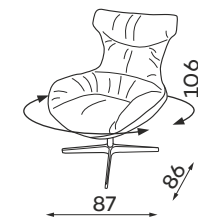

FOOTREST

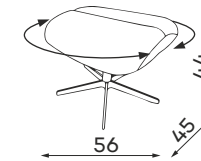

ARMCHAIR

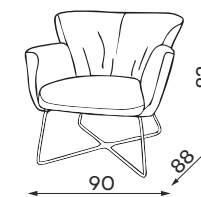

BERRY



MUSSA



JUNA



ARMCHAIR

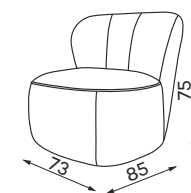

SWIVEL ARMCHAIR

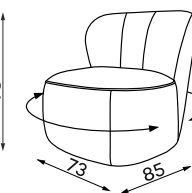

FOOTREST

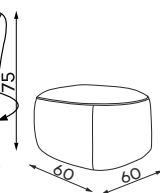

ARMCHAIR

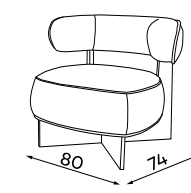

ARMCHAIR

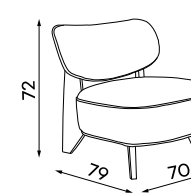

FOOTREST

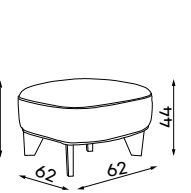

All corners and modules can be ordered with either a left or right-hand layout.
All figures shows the left-hand side.

Size tolerance for upholstered furniture +/- 4 cm.
All dimensions and configurations of furniture can be found at www.befame.com

be famous
for beauty
and
comfort



contact@befame.com
marketing@befame.com

V.2